

GRÚA DE PISCINA + ZÓCALO A

GRÚA DE PISCINA

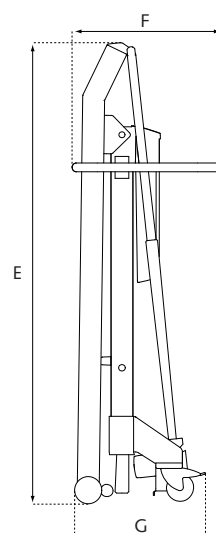
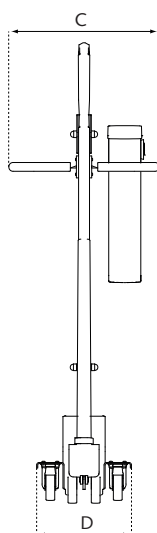
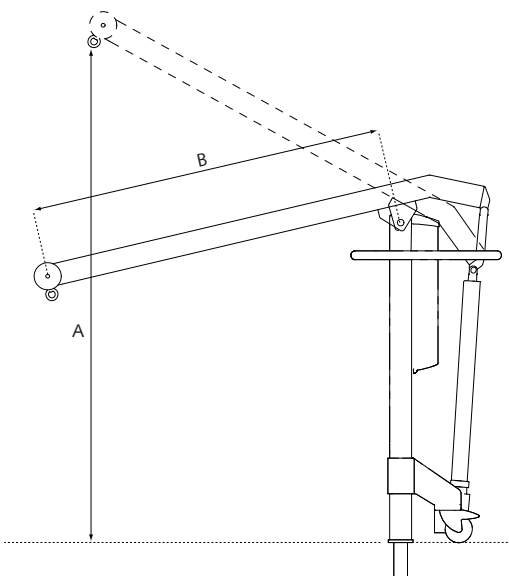

Dimensiones (mm)

A	1840
B	1305
C	540
D	350
E	1700
F	550
G	500

Carga de trabajo segura	135 kg
Baterías	2 x 12 Vdc; 6,5 - 7,2 Ah
Cargador	independiente

Diámetro de las ruedas	100 mm
Estructura	acero inoxidable
Control manual	eléctrico (IP67)

ZÓCALO A



SUJECCIÓN DEL CUERPO

Sujeción del cuerpo

S	ref. 1025
S con revestimiento electrolítico (anticorrosivo)	ref. 1027

y sujeciones antideslizantes para los muslos ref. 1080

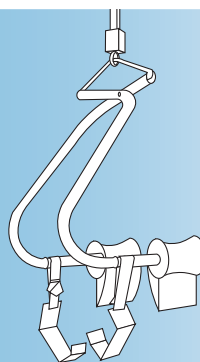

Arnés estándar con sujeción de la cabeza con forma de luna y faldillas acolchadas para los muslos

XS	ref. 3433
S	ref. 3430
M	ref. 3431
L	ref. 3432
XL	ref. 3434

con barra de equilibrio ref. 2110 + 2111

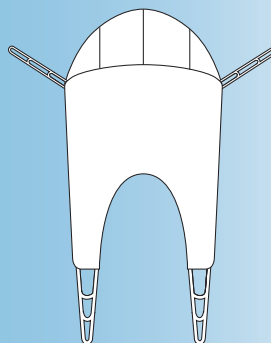
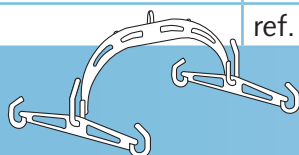

Arnés del asiento (PVC)

Un tamaño	ref. 3473
-----------	-----------

con barra de equilibrio ref. 2110

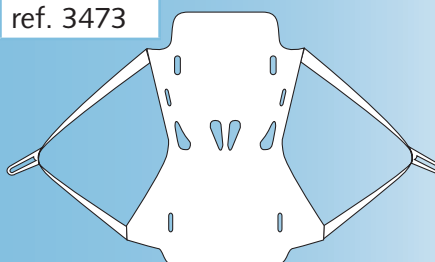
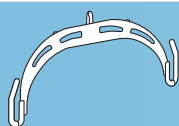

Arnés para ir al baño (PVC)

XS	ref. 3476
S	ref. 3463
M	ref. 3464
L	ref. 3465
XL	ref. 3477

con barra de equilibrio ref. 2110

